



F7 IIG is one professional custom plastic mould manufacturer, which is specialized in designing ,manufacturing and produce all kinds of plastic Injection moulds and plastic parts to International Customers.

F7 IIG service uses the latest versions of Pro-E, U.G, Solidworks ,Auto-CAD to output designs. The design team has many years of experience in concept Design ,It can provide and concept designs from the earliest stage of any project.

F7 IIG follows this eternal quality policy: Customer's satisfaction is our permanent pursuit. Quality Is always our first promise . All the moulds supplies by our company with the features as follows: high precision, long life, short production period & delivery time , reasonable price, satisfactory service, have enjoyed good popularity and high credit.

F7 IIG people will double our effort to develop with our customers, and create a most brilliant future.

F7 IIG FLOW CHART

We deliver the mould quotation to the customer upon receipt of your samples, drawings & requirements.

After the approval on quotation and mould form F7 IIG will work on 3D mould drawings, that will send to the customer for approval.

After the approval on 3D, F7 IIG will work on the detailed 2D mould drawings, that will send to the customer for approval.

After the approval on mould drawings ,the Production Dept. begins the tooling ,following and updating the tooling and processing schedule weekly.

We send to the customer weekly the photographic report of the mould progress.

Mould testing: We will inform you the date, F7 IIG will send the samples inspection report & injection parameters with the samples to you.

We deliver the mould to the customer together with mould assemble once get your instruction & confirmation for shipment.



THIN WALL MOULD



THIN WALL MOULD

Thin-wall container, Thin-wall bucket, Thin-wall disposable goods

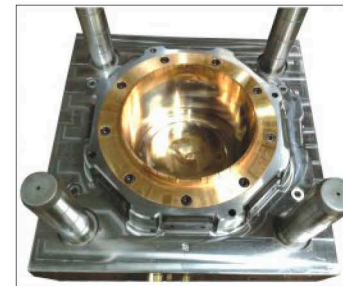
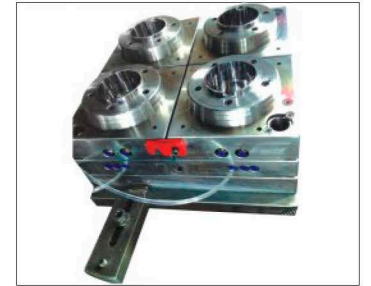

COMMODITY MOULD

Good production good service lead to success, we are dedicated to provide you reasonable price with the best service and products

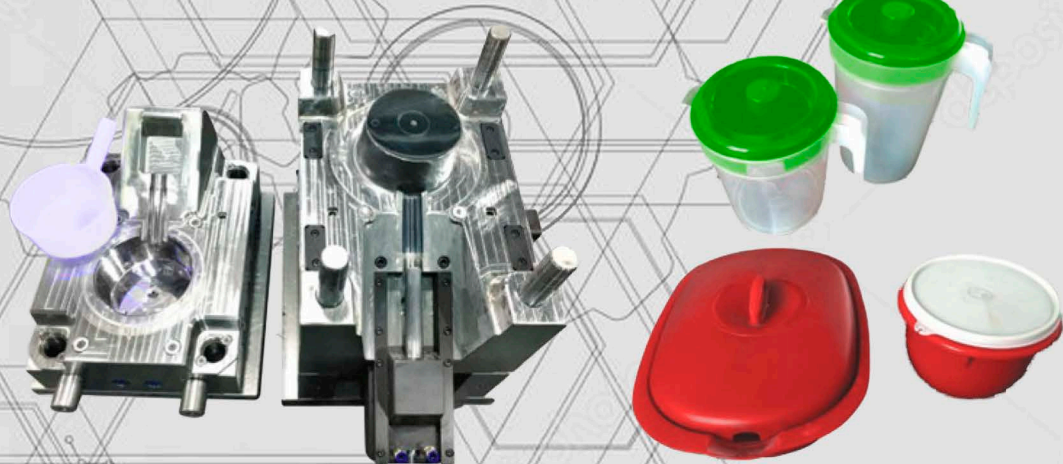
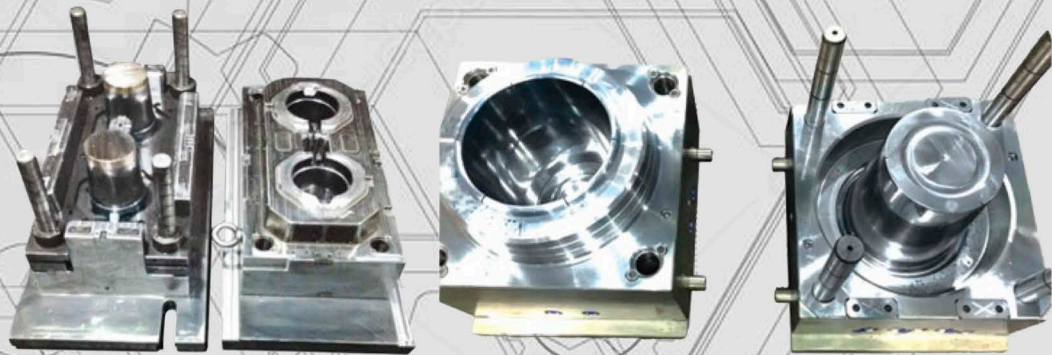

COMMODITY MOULD

F7 IIG professional design all kinds of daily necessities plastic mould such as: kitchenware products moulds, baby toy moulds, flowers pots moulds, and other daily necessities.

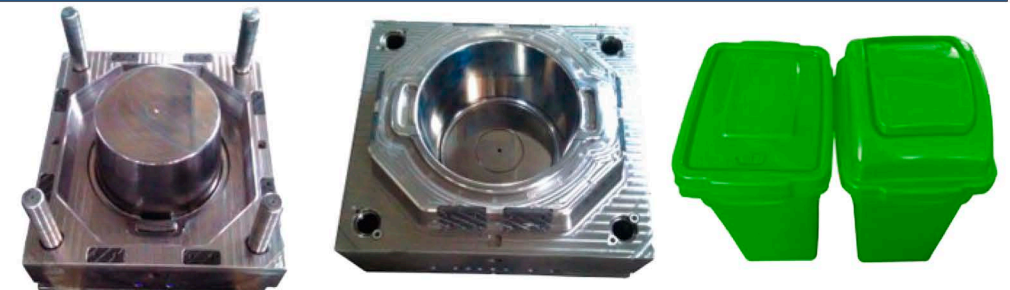

BUCKET MOULD

F7 IIG professionally design and manufacture all kinds of bucket moulds, Such as water bucket mould, paint pail mould, household dustbin mould. Every year we make about 120 sets of bucket moulds for the oversea market.

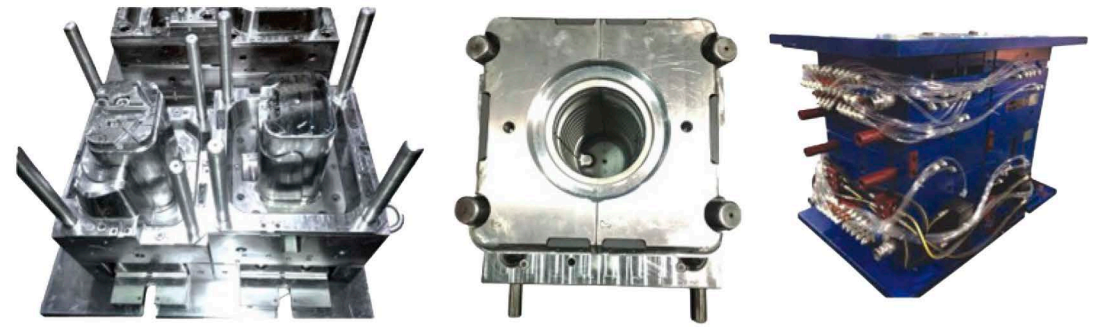
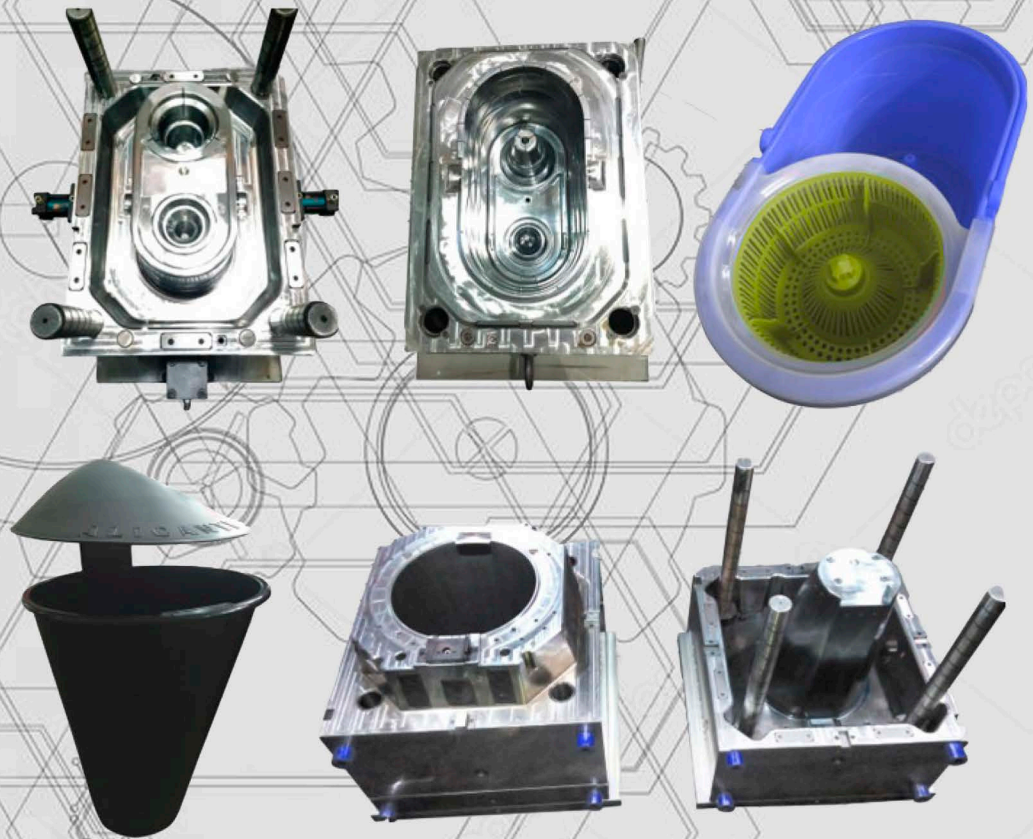

BASKET CRATE MOULD

Basket Crate mould is the core of our business for many years. You can be sure that with our many years experience, we can steer you in the right direction, and help you develop the basket crate as your need.

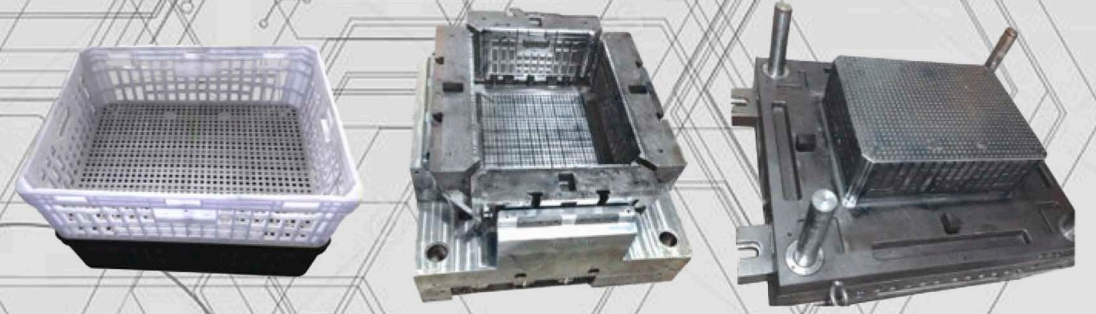
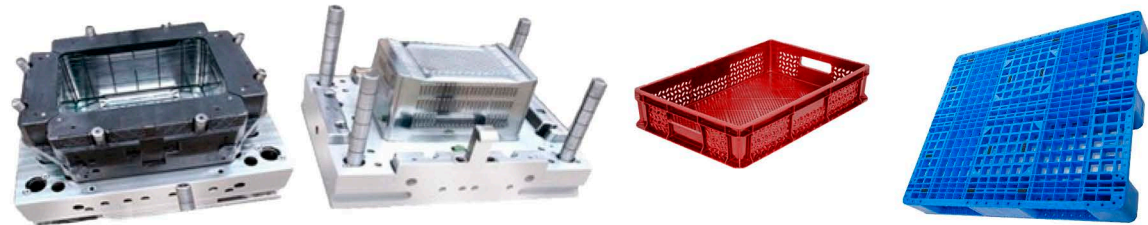
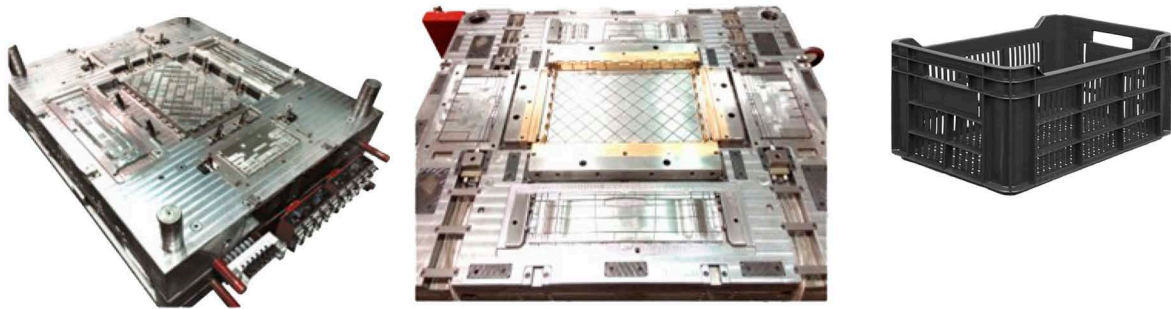

BASKET CRATE MOULD

Good design makes longer mould life, Each cavity self-lock independently, to ensure low decentration & precision of the product, each mould spare part is inserted. With durable parts, which are interchangeable - in order to improve and achieve high production efficiency.

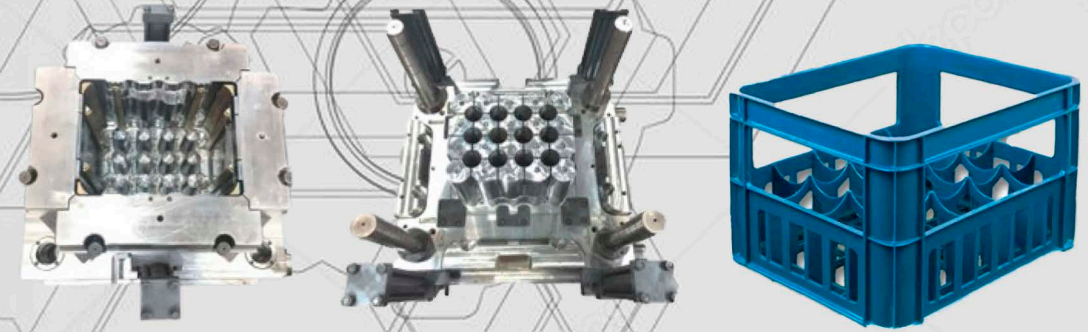

FURNITURE MOULD

F7 IIG mould offers all kinds of furniture mould, such as chair mould, table mould, stool mould, folding stool mould and so on.

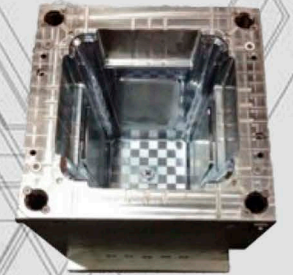
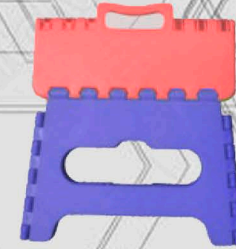
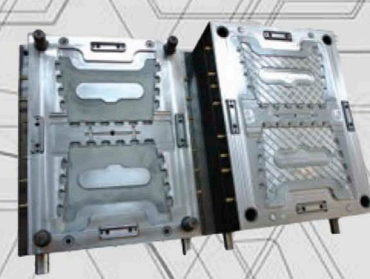
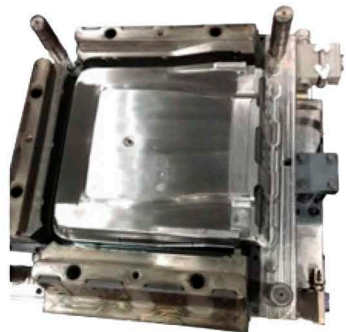
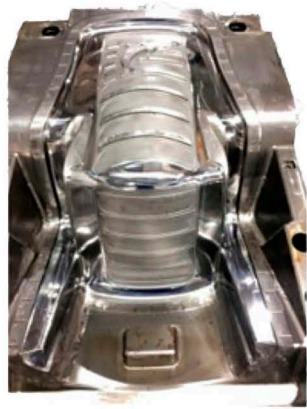

FURNITURE MOULD

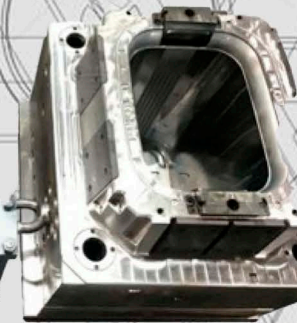
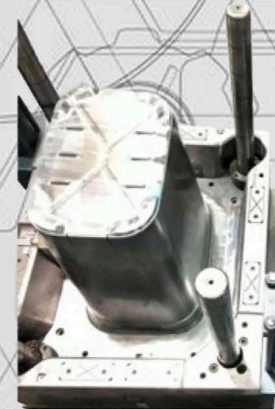

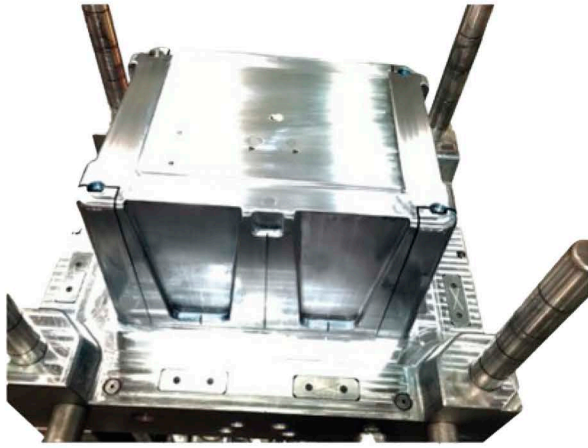

AIR COOLER MOULD

F7 IIG has manufactured many kinds of whole set Air cooler moulds. Including water tank, grill, control panel, motor and so on. Ensure perfect assembly for each style.



AIR COOLER MOULD

Mainly specialized in producing car part moulds, such as front and rear lamp mould, fan tray mould, feder mould, and interior trim parts moulds.

